

XC300 / XC600

EN

OPERATING MANUAL  
THERMAL IMAGING CAMERA



 TROTEC

**Table of contents**

Notes regarding the operating manual..... 2

Safety ..... 2

Information about the device..... 5

Transport and storage..... 11

Operation ..... 11

Software..... 17

Emissivity..... 27

Thermography terms ..... 29

Errors and faults ..... 31

Maintenance and repair ..... 32

Disposal ..... 32

**Notes regarding the operating manual**

**Symbols**

 **Warning of electrical voltage**  
This symbol indicates dangers to the life and health of persons due to electrical voltage.

 **Warning of laser radiation**  
This symbol indicates dangers to the health of persons due to laser radiation.

 **Warning**  
This signal word indicates a hazard with an average risk level which, if not avoided, can result in serious injury or death.

 **Caution**  
This signal word indicates a hazard with a low risk level which, if not avoided, can result in minor or moderate injury.

**Note**  
This signal word indicates important information (e.g. material damage), but does not indicate hazards.

 **Info**  
Information marked with this symbol helps you to carry out your tasks quickly and safely.

 **Follow the manual**  
Information marked with this symbol indicates that the operating manual must be observed.

You can download the current version of the operating manual and the EU declaration of conformity via the following link:



XC300



<https://hub.trotec.com/?id=41995>

XC600



<https://hub.trotec.com/?id=42958>

**Safety**

**Read this manual carefully before starting or using the device. Always store the manual in the immediate vicinity of the device or its site of use!**

 **Warning**  
**Read all safety warnings and all instructions.** Failure to follow the warnings and instructions may result in electric shock, fire and / or serious injury. **Save all warnings and instructions for future reference.**  
This appliance can be used by children aged from 8 years and above and persons with reduced physical, sensory or mental capabilities or lack of experience and knowledge if they have been given supervision or instruction concerning use of the appliance in a safe way and understand the hazards involved. Children shall not play with the appliance. Cleaning and user maintenance shall not be made by children without supervision.

- Do not use the device in potentially explosive rooms.
- Do not use the device in aggressive atmosphere.
- Do not immerse the device in water. Do not allow liquids to penetrate into the device.
- The device may only be used in dry surroundings and must not be used in the rain or at a relative humidity exceeding the operating conditions.
- Protect the device from permanent direct sunlight.
- Do not remove any safety signs, stickers or labels from the device. Keep all safety signs, stickers and labels in legible condition.
- Do not open the device with a tool.

- Avoid looking directly into the laser beam.
- Never point the laser beam at people or animals.
- Observe the storage and operating conditions as given in the Technical data chapter.

### Intended use

Only use the device for visual or thermographic representation of objects whilst adhering to the technical data.

To use the device for its intended use, only use accessories and spare parts which have been approved by Trotec.

### Improper use

Do not use the device in potentially explosive areas. Never use the device on persons or animals. Trotec accepts no liability for damages resulting from improper use. In such a case, any warranty claims will be voided. Any unauthorised modifications, alterations or structural changes to the device are forbidden.

### Personnel qualifications

People who use this device must:

- have read and understood the operating manual, especially the Safety chapter.

### Residual risks



#### Warning of electrical voltage

There is a risk of a short-circuit due to liquids penetrating the housing!

Do not immerse the device and the accessories in water. Make sure that no water or other liquids can enter the housing.



#### Warning of electrical voltage

Work on the electrical components must only be carried out by an authorised specialist company!



#### Warning of electrical voltage

Before any work on the device, remove the mains plug from the mains socket and the battery from the device! Hold onto the mains plug while pulling the power cable out of the mains socket.



#### Warning of explosive substances

Do not expose the battery to temperatures above 45 °C! Do not let the battery come into contact with water or fire! Avoid direct sunlight and moisture. There is a risk of explosion!



#### Warning of laser radiation



**Laser class 2, P max.: < 1 mW, λ: 650 nm, EN 60825-1:2014**

Do not look directly into the laser beam or the opening from which it emerges.

Never point the laser beam at people, animals or reflective surfaces. Even brief eye contact can lead to eye damage.

Examining the laser output aperture by use of optical instruments (e.g. magnifying glass, magnifiers and the like) entails the risk of eye damage.

When working with a laser of class 2, observe the national regulations on wearing eye protection.



#### Warning

Risk of suffocation!

Do not leave the packaging lying around. Children may use it as a dangerous toy.



#### Warning

The device is not a toy and does not belong in the hands of children.



#### Warning

Dangers can occur at the device when it is used by untrained people in an unprofessional or improper way! Observe the personnel qualifications!

**Caution**

Lithium-ion batteries might catch fire in case of overheating or damage. Ensure a sufficient distance to heat sources, do not subject lithium-ion batteries to direct sunlight and make sure not to damage the casing. Do not overcharge lithium-ion batteries. Only use smart chargers that switch off automatically when the battery is fully charged. Charge lithium-ion batteries in due time before they are discharged completely.

**Caution**

Keep a sufficient distance from heat sources.

**Note**

To prevent damages to the device, do not expose it to extreme temperatures, extreme humidity or moisture.

**Note**

Do not use abrasive cleaners or solvents to clean the device.

## Information about the device

### Device description

The thermal camera XC300 / XC600 creates a visible image depicting infrared radiation, which is otherwise invisible to the human eye. The thermal image and temperature are displayed on the screen in real time. To improve the view, you can select various colour palettes for depicting the thermal image.

Furthermore, you can superimpose IR and digital images (IR DuoVision Plus) and adjust the associated intensity (IR DuoVision) in order to obtain a higher-contrast thermal image.

For a measured result which is as precise as possible the ambient temperature, reflected temperature, relative humidity, distance and emissivity can be entered.

An integrated distance meter allows you to determine distances to the measuring object precisely and automatically if required.

The autofocus function permits automatic focussing of the desired measuring object.

A list of emissivities for various surfaces is provided in the chapter Emissivity. For a precise evaluation, the thermal image on the screen can be frozen or stored in the internal device memory. The saved images can later be viewed either directly on the camera screen or on a PC using an analysis software.

To edit the images, you can download the IR-Report 2.X STD software from the download (or service) section of [www.trotec.com](http://www.trotec.com).

### Device depiction

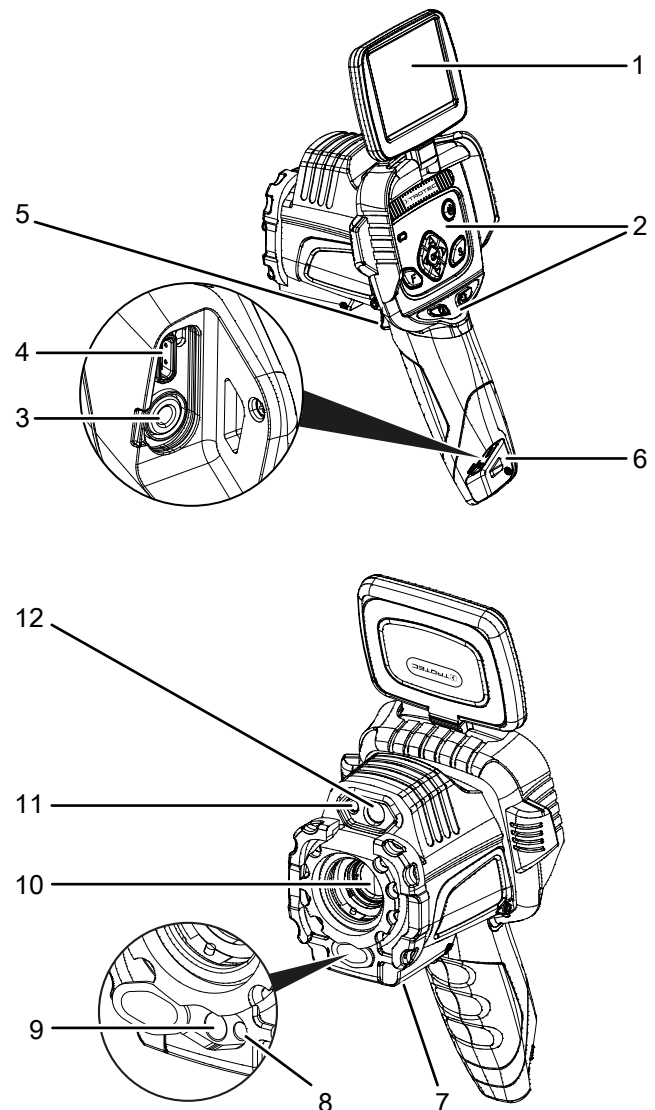

No.	Designation
1	Display
2	Control panel
3	AV output with sealing cap
4	USB type C port
5	Multifunction button
6	Wrist strap holder
7	1/4" tripod thread
8	Laser pointer
9	Receiver lens for laser beam
10	Infrared lens with protective cap
11	LED
12	Camera

**Control panel**

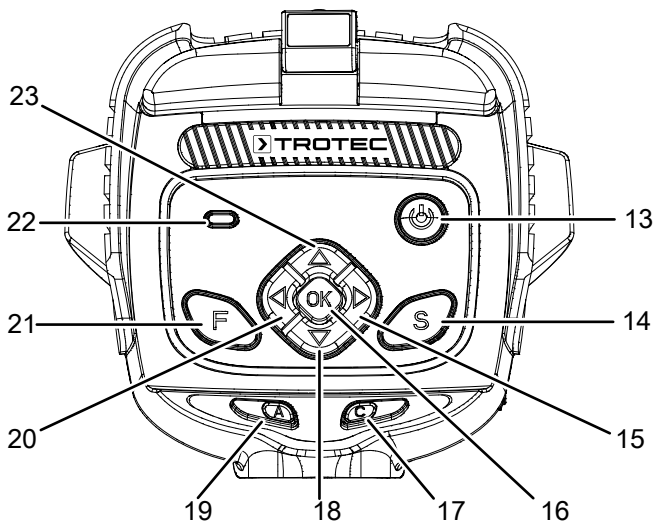

No.	Designation	Meaning
13	Power button	Switching the device on and off
14	S button: Activate freezing the image or take a photo	Press briefly to freeze the current image, press and hold for approx. 5 s to take a photo
15	Arrow button right / LEVEL up	Button for menu control, level control
16	OK button	Confirming the entry
17	C button: Main menu or Back button	Returning directly to the main menu or to the previous menu
18	Arrow button down / decrease SPAN	Button for menu control, SPAN control
19	A button: Shutter button / automatic adjustment	Performing an automatic adjustment (calibration)
20	Arrow button left / LEVEL down	Button for menu control, level control
21	F button: Activate focussing of the measuring object	Activating the manual / automatic focus
22	Battery LED (illuminated while charging)	Red (battery is charging), green (battery is fully charged)
23	Arrow button up / increase SPAN	Button for menu control, SPAN control

**Display**

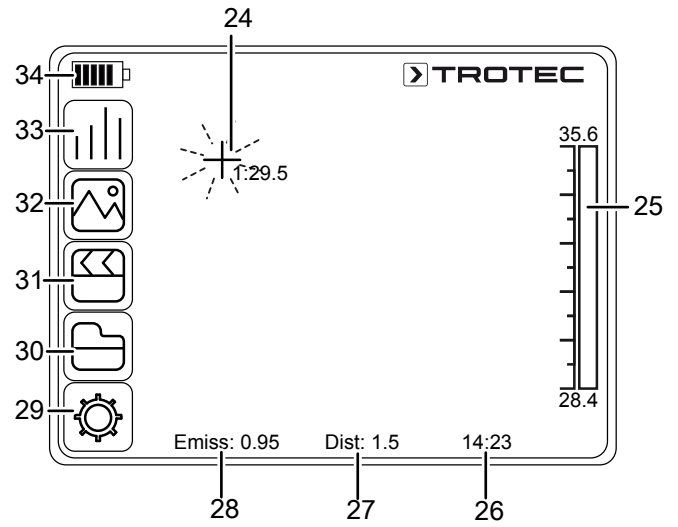

No.	Designation
24	Measuring point
25	Temperature scale (dynamic)
26	Time indication
27	Distance indication
28	Indication of the emissivity
29	Settings menu
30	File menu
31	Media menu
32	Image menu
33	Analysis menu
34	Battery status indicator

## Technical data

Parameter		Value
Model		<b>XC300</b>
Article number		3.110.003.043
Measurement	Temperature range	-20 °C to +600 °C (optionally even up to +1,500 °C)
	Accuracy	± 2 °C, ± 2 % from the measured value
Radiometric image performance	Detector type	UFPA
	Detector resolution	384 x 288 pixels
	Spectral range	8 to 14 µm
	Field of vision (FOV)	24° x 18°
	Geometric resolution	1.1 mrad
	Thermal sensitivity	0.05 °C at 30 °C
	Refresh rate	50/60 Hz
	Focus / min. focus distance	Automatic and manual / 0.15 m
Visual image performance	Digital photo camera	5 megapixels, integrated photo lamp
	Video norm	PAL / NTSC
Image representation	Display	Tiltable, swivel-mounted 3.5-inch LCD touchscreen, capacitive
	Image display	Pseudo colours, 6 colour palettes
	Image display options	IR image, real image, DuoVision Plus display (overlay of infrared and real images in random intensities), DuoVision Plus display (fusion of infrared and real image as contour emphasizing detail-enhanced thermogram)
Measurement and analysis	Measuring points	8 movable temperature measuring spots (can be freely configured)
	Measuring functions	Isotherm, line profile analysis, sector analysis (rectangle), various alarm functions, Min/Max temperature tracking (hot/cold spot), differential measurements at up to 8 dynamic temperature measuring spots
	Area measurement	2 areas
	Emissivity	User-defined variably adjustable from 0.01 to 1.0
	Measurement correction	Correction of the reflected object temperature; automatic correction based on user-defined specifications for ambient temperature, distance, relative humidity
Data storage	Memory	16 GB internal flash memory
	File format	Radiometric image: 16 bit JPEG; visual image: JPEG; non-radiometric thermographic video: MPEG-4; fully radiometric infrared video: 14 bit IR format
	Data storage / transmission	Storage of non-radiometric IR videos (MPEG-4) as well as radiometric and real images on internal memory; storage of fully radiometric IR videos* on PC via USB 2.0
	Voice recording	Comments can be stored along with every IR image (optionally available Bluetooth headset required)
	Ports	USB type C, analogue video (PAL / NTSC)
Laser	Type	Semiconductor AlGaInP diode laser class 2, 1 mW / 635 nm red
	Distance measurement	1 to 30 m
Power supply	Battery type	High-capacity Li-ion battery (9,120 mAh); rechargeable, exchangeable
	Operating time	≈ 8 h
	Mains power	5 V, 2 A
	Energy saving mode	User-defined

Parameter		Value
Ambient conditions	Temperature	-20 °C to +50 °C (operation), -40 °C to +70 °C (storage)
	Humidity	10 % to 95 % RH (non-condensing)
	Type of protection / shock / vibration	IP54 / 25G / 2G
	Impact resistance (falling from)	2 m
Physical characteristics	Dimensions (length x width x height)	130 x 125 x 250 mm
	Weight	850 g
	Tripod mounting	1/4 inch – 20
* Saving fully radiometric IR videos requires the optionally available real-time upgrade.		



Parameter		Value
Model		<b>XC600</b>
Article number		3,110,003,044
Measurement	Temperature range	-20 °C to +600 °C (optionally even up to +1,500 °C)
	Accuracy	± 2 °C, ± 2 % from the measured value
Radiometric image performance	Detector type	UFPA
	Detector resolution	640 x 480 pixels
	Spectral range	8 to 14 µm
	Field of vision (FOV)	24° x 18°
	Geometric resolution	0.65 mrad
	Thermal sensitivity	0.06 °C at 30 °C
	Refresh rate	50/60 Hz
	Focus / min. focus distance	Automatic and manual / 0.35 m
Visual image performance	Digital photo camera	5 megapixels, integrated photo lamp
	Video norm	PAL / NTSC
Image representation	Display	Tiltable, swivel-mounted 3.5-inch LCD touchscreen, capacitive
	Image display	Pseudo colours, 6 colour palettes
	Image display options	IR image, real image, DuoVision Plus display (overlay of infrared and real images in random intensities), DuoVision Plus display (fusion of infrared and real image as contour emphasizing detail-enhanced thermogram)
Measurement and analysis	Measuring points	8 movable temperature measuring spots (can be freely configured)
	Measuring functions	Isotherm, line profile analysis, sector analysis (rectangle), various alarm functions, Min/Max temperature tracking (hot/cold spot), differential measurements at up to 8 dynamic temperature measuring spots
	Area measurement	2 areas
	Emissivity	User-defined variably adjustable from 0.01 to 1.0
	Measurement correction	Correction of the reflected object temperature; automatic correction based on user-defined specifications for ambient temperature, distance, relative humidity
Data storage	Memory	16 GB internal flash memory
	File format	Radiometric image: 16 bit JPEG; visual image: JPEG; non-radiometric thermographic video: MPEG-4; fully radiometric infrared video: 14 bit IR format
	Data storage / transmission	Storage of non-radiometric IR videos (MPEG-4) as well as radiometric and real images on internal memory; storage of fully radiometric IR videos* on PC via USB 2.0
	Voice recording	Comments can be stored along with every IR image (optionally available Bluetooth headset required)
	Ports	USB type C, analogue video (PAL / NTSC)
Laser	Type	Semiconductor AlGaInP diode laser class 2, 1 mW / 635 nm red
	Distance measurement	1 to 30 m
Power supply	Battery type	High-capacity Li-ion battery (9,120 mAh); rechargeable, exchangeable
	Operating time	≈ 8 h
	Mains power	5 V, 2 A
	Energy saving mode	User-defined

Parameter		Value
Ambient conditions	Temperature	-20 °C to +50 °C (operation), -40 °C to +70 °C (storage)
	Humidity	10 % to 95 % RH (non-condensing)
	Type of protection / shock / vibration	IP54 / 25G / 2G
	Impact resistance (falling from)	2 m
Physical characteristics	Dimensions (length x width x height)	232 x 115 x 168 mm
	Weight	850 g
	Tripod mounting	1/4 inch – 20
* Saving fully radiometric IR videos requires the optionally available real-time upgrade.		

### Scope of delivery

- 1 x Thermal imaging camera with standard lens 24° x 18°
- 1 x Charger
- 1 x Battery (integrated)
- 1 x Video cable
- 1 x USB type C cable
- 1 x Manual
- 1 x Transport case
- 1 x Temperature test certificate
- 1 x Software (via download)

## Transport and storage

### Note

If you store or transport the device improperly, the device may be damaged.

Note the information regarding transport and storage of the device.

### Transport

For transporting the device, use the transport case included in the scope of delivery in order to protect the device from external influences.

The supplied Li-ion batteries are subjects to the requirements of dangerous goods legislation.

Observe the following when transporting or shipping Li-ion batteries:

- The user may transport the batteries by road without any additional requirements.
- If transport is carried out by third parties (e.g. air transport or forwarding company), special requirements as to packaging and labelling must be observed. This includes consulting a dangerous goods specialist when preparing the package.
  - Only ship batteries if their housing is undamaged.
  - Mask open terminals with tape and pack the battery in a way that it cannot move inside the packaging.
  - Please also observe any other national regulations.

### Storage

When the device is not being used, observe the following storage conditions:

- dry and protected from frost and heat
- protected from dust and direct sunlight
- For storing the device, use the transport case included in the scope of delivery in order to protect the device from external influences.
- The storage temperature is the same as the range given in the Technical data chapter.
- When storing the device for an extended period of time, remove the battery/batteries.

## Operation

### Switching the device on



#### Warning of laser radiation

**Laser class 2, P max.: < 1 mW, λ: 650 nm, EN 60825-1:2014**

Do not look directly into the laser beam or the opening from which it emerges.

Never point the laser beam at people, animals or reflective surfaces. Even brief eye contact can lead to eye damage.

Examining the laser output aperture by use of optical instruments (e.g. magnifying glass, magnifiers and the like) entails the risk of eye damage.

When working with a laser of class 2, observe the national regulations on wearing eye protection.

1. Open the display (1).

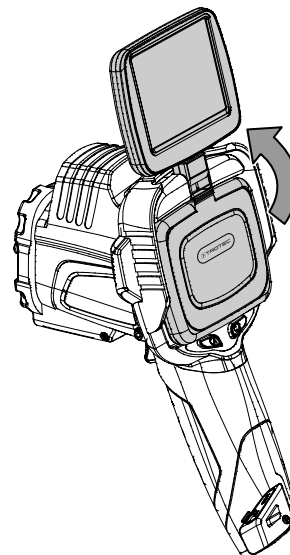

2. Open the protective cap at the IR lens (10) and swivel the protective cover of the laser pointer (8) to the side by 180°.

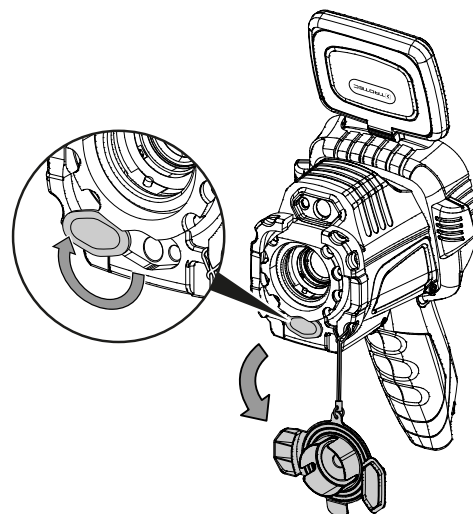

3. Press the on/off button (13) for approx. 5 seconds.
  - ⇒ The buttons on the control panel (2) light up in green.
  - ⇒ The Trotec logo is displayed.
4. Wait a moment until the device has started up completely.
  - ⇒ A current IR image and the start screen appear on the display:



### Setting the language

Please proceed as follows to set the language for the menu texts:

1. Press the C button (17) on the control panel (2) or tap the Trotec logo on the display (1).
  - ⇒ The main menu is displayed on the left-hand side of the display (1).
2. Select the *Settings* menu.
3. Select the *System* menu.
4. Press the *Language* button.
5. Swipe your finger through the list of available languages.
6. Swipe to select the desired language.
7. Confirm the selection by pressing the *OK* button.
8. Wait a moment.
  - ⇒ The desired language has been selected and set.

### Setting date and time

Please proceed as follows to set the date and time for the system and the time stamp on the images / videos:

1. Press the C button (17) on the control panel (2) or tap the Trotec logo on the display (1).
  - ⇒ The main menu is displayed on the left-hand side of the display (1).
2. Select the *Settings* menu.
3. Select the *System* menu.
4. Press the *Date & Time* button.
5. Swipe to select the desired date.
6. Confirm your selection with *OK*.
7. Press the *Set time* button.
8. Swipe to select the desired time.
9. Confirm your selection with *OK*.
10. Press the *Set timezone* button.

11. Swipe to select the desired timezone.
12. Confirm your selection with *OK*.
  - ⇒ Date and time have been selected and set.

### Calibrating and focussing the IR camera



#### Info

You can also assign this function to the multifunction button (5). Further information on the multifunction button is provided in the chapter *Configuring the multifunction button*.

During a calibration, the camera performs an automatic adjustment (calibration) to the temperatures in the image section. An image that is not sharply focussed leads to deviations in the temperature measurement!

Proceed as follows to perform an automatic adjustment (calibration), and to automatically focus the IR camera on an object to be thermographed:

1. Point the device at the object to be thermographed with the IR lens (10) open.
2. Press the Shutter button (19).
  - ⇒ The internal shutter of the IR camera closes briefly and an automatic adjustment (calibration) to the temperatures in the image section is performed.

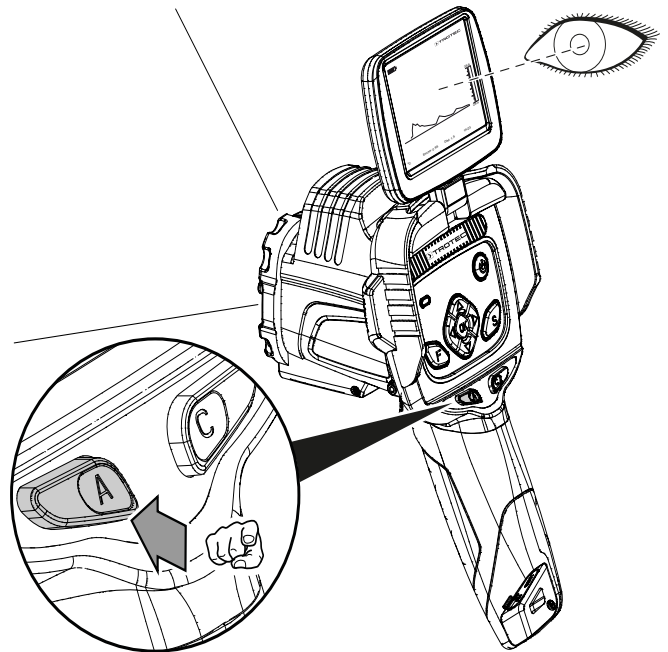

3. Press the F button (21) if it is not already illuminated in blue.
  - ⇒ The colour of the F button changes from green to blue.
  - ⇒ The focus function is activated.
4. Tap the object you want to focus on the display.

- The object to be thermographed is sharply focussed.

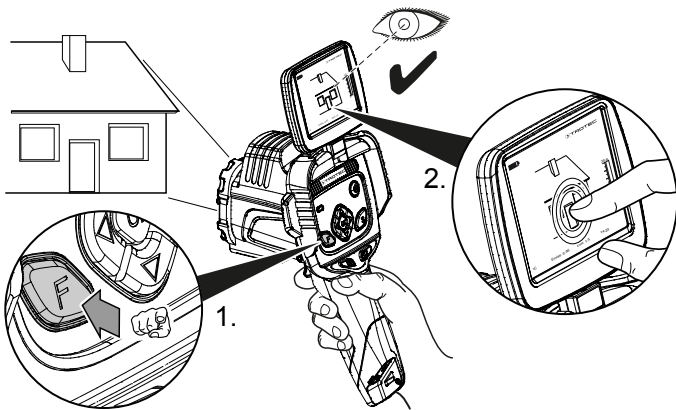

### Taking/recording an infrared image/video



#### Info

You can also assign this function to the multifunction button (5). Further information on the multifunction button is provided in the chapter *Configuring the multifunction button*.

Recording of IR images and videos can be started from the main menu.

- Press the C button (17) on the control panel (2) or tap the Trotec logo on the display (1).
  - ⇒ The main menu is displayed on the left-hand side of the display.
- Select the *Media* menu.

Please proceed as follows to record and save an infrared image:

- Press the *Snapshot* button.
  - ⇒ The photo is taken and saved.
  - ⇒ The storage path of the recorded infrared image is briefly shown on the display.
  - ⇒ The *Media* menu is displayed again.

Please proceed as follows to record and save a video:

- Press the *Video* button.
  - ⇒ The recording is started.
  - ⇒ A recording icon (red circle) and the recording time appear in the middle of the top display edge.
- Press the *Video* button again to stop recording.
  - ⇒ The video is saved.
- Press the *Play* button, to play the recorded video directly on the display.

### Configuring the multifunction button

The multifunction button (5) can be assigned with various functions.

Setting	Function
<i>Lock</i>	Shutter function for calibration
<i>Freeze</i>	Activate or deactivate freezing the image
<i>Snapshot</i>	Taking a picture
<i>Laser</i>	Switching the laser on or off
<i>LED</i>	Switching the LED on or off

Please proceed as follows to configure the multifunction button:

- Press the C button (17) on the control panel (2) or tap the Trotec logo on the display (1).
  - ⇒ The main menu is displayed on the left-hand side of the display.
- Select the *Settings* menu.
- Select the *System* menu.
- Select the *Control* menu.
- Press the *Multi-Func Key* button.
- Select the desired setting.
- Leave the *Settings* menu.
  - ⇒ The desired setting is saved.

### Configuring the quick launch button

The quick launch button allows fast access to the *Image* menu and can be freely positioned on the screen.

Please proceed as follows to activate / deactivate the quick launch button:

1. Press the C button (17) on the control panel (2) or tap the Trotec logo on the display (1).  
⇒ The main menu is displayed on the left-hand side of the display.
2. Select the *Settings* menu.
3. Select the *Image* menu.
4. Activate the quick launch button by sliding the selector switch to the right.
5. Leave the *Settings* menu.  
⇒ The quick launch button is activated and displayed.



6. Press and hold the quick launch button to move it to the desired position.
7. Briefly press the quick launch button to open the *Image* menu.

### Inserting / Changing the lens



**Info**

The camera automatically recognizes which lens has been connected, and automatically uses the calibration curve stored for this lens. For this purpose, however, the lens must first be calibrated for the respective camera. Otherwise, there is a danger of the camera displaying incorrect values. The lens included in the scope of delivery has already been calibrated for the camera by the manufacturer prior to delivery. When ordering additional lenses, please contact the manufacturer for calibration.

Proceed as follows to equip the camera with a suitable Trotec lens:

1. Place the lens on the camera as shown below. Before attaching the lens, align the three round holes as shown in the illustration. Otherwise, automatic recognition will not work later on. If necessary, slightly turn the lens in both directions until the grooves noticeably engage in the corresponding pins inside the lens mount.

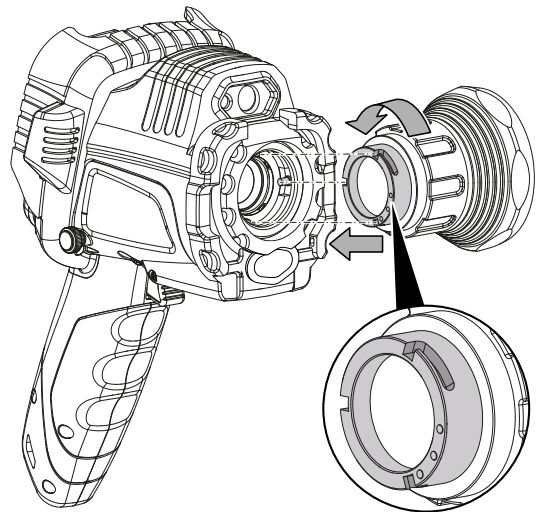

2. Rotate the lens clockwise until it is firmly attached to the camera head.

### Data transfer via USB

You can either access and read out the data stored on the device using a USB type C data cable, or transfer the data to the software (optional PRO version) in real time and thus record fully radiometric infrared videos.

To do so, first select the desired transmission mode in the settings:

- *USB Mode* (data memory access)
- *Trans.* (real-time data transmission to software)

1. Press the C button (17) on the control panel (2) or tap the Trotec logo on the display (1).  
⇒ The main menu is displayed on the left-hand side of the display.
2. Select the *Settings* menu.
3. Select the *System* menu.
4. Select the *Control* menu.
5. Press the *USB Mode* button.
6. Swipe to select the desired transmission mode.
7. Leave the *Settings* menu.
8. Connect the supplied micro USB data cable to the device.
9. Connect the data cable to a PC or notebook.



**Info**

You also have to start data transmission in the software (optional PRO version) in order to connect the device.

To transmit fully radiometric real-time IR videos to your PC using a USB type C data cable (only possible in combination with the optionally available IC report PRO software), please proceed as follows:

1. Connect the optionally available dongle of the IC report analysis software PRO version to a free USB port of your PC. Without the dongle, the extension of the USB interface in the analysis software is locked.
2. Open the IC report software and activate the *Trans.* transmission mode at the camera.
3. Connect the PC to the camera using the supplied USB cable.
4. If the IC report analysis software was properly installed beforehand, the PC's operating system will automatically identify the connected camera and install all necessary drivers.

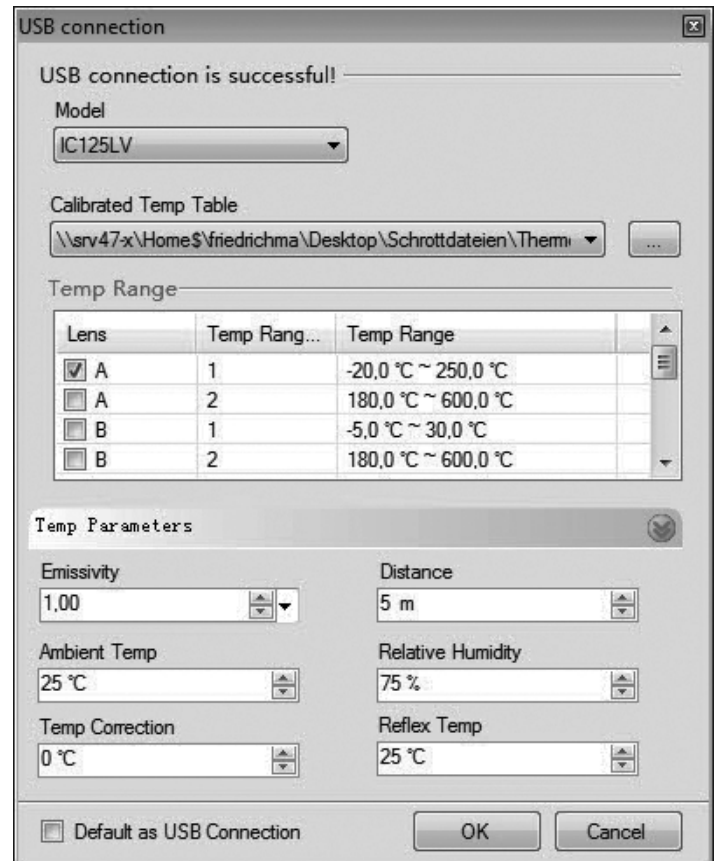

5. After the drivers have been successfully installed, the camera will be detected as mass storage device every time it is connected to the PC.
6. In the menu of the analysis software select the item *Monitoring – Connect USB* or click directly onto the USB symbol.
7. Select the type of camera you want to connect to your computer in the submenu that opens.

8. Now enter the path of the location where the calibration table (dataload.bin file) is to be saved on your computer.
9. Select the applicable temperature range.
10. Confirm with *OK*.
  - ⇒ The live image of the camera appears in the software's analysis window.



### Info

The calibration table that corresponds to the camera is bound to the serial number and only valid for the respective device connected.

## Switching the laser pointer on or off

The integrated laser can be used as both a pure aid to orientation and for aiming and a means to exactly measure the distance between the IR camera and the object to be thermographed.

Please proceed as follows to switch the laser pointer on or off:



### Warning of laser radiation

**Laser class 2, P max.: < 1 mW, λ: 650 nm, EN 60825-1:2014**

Do not look directly into the laser beam or the opening from which it emerges.

Never point the laser beam at people, animals or reflective surfaces. Even brief eye contact can lead to eye damage.

Examining the laser output aperture by use of optical instruments (e.g. magnifying glass, magnifiers and the like) entails the risk of eye damage.

When working with a laser of class 2, observe the national regulations on wearing eye protection.

- ✓ The protective cover of the laser pointer (8) is opened by swivelling it to the side by 180°.
- 1. Press the C button (17) on the control panel (2) or tap the Trotec logo on the display (1).
  - ⇒ The main menu is displayed on the left-hand side of the display.
- 2. Select the *Settings* menu.
- 3. Select the *System* menu.
- 4. Select the *Control* option.
- 5. Activate the laser permanently by sliding the selector switch on the display to the right.
  - ⇒ The laser pointer is switched on and pulsates at regular intervals.
  - ⇒ The *Laser* selector switch is highlighted in blue (OM).
  - ⇒ Additionally, a red cursor is displayed to mark the target.
- 6. Deactivate the laser permanently by sliding the selector switch on the display to the left.
 

Please observe that the integrated laser does not only constitute a pure means for aiming or an aid to orientation, but that it can also be utilized for carrying out an exact measuring of the distance to the measuring object. If you have programmed the laser function to the multifunction button (5), you can activate or deactivate the laser by pressing this button. Further information on the multifunction button is provided in the chapter *Configuring the multifunction button*. In the active state, the laser pulsates at regular intervals, measuring the distance from the camera to the measuring object in each case. You do not have to press the trigger to carry out this process. The distance measured is displayed at the lower right end of the LCD screen and is also automatically updated in the *Global Parameters* menu item.
- 7. Close the protective cover of the laser pointer (8).



### Info

When the laser is not active, the distance to the measuring object must be entered manually to obtain measurement results that are as precise as possible.

## Using the AV port

You can connect the device to a screen via an AV cable. The image can be transmitted in PAL or NTSC format.

1. Press the C button (17) on the control panel (2) or tap the Trotec logo on the display (1).
  - ⇒ The main menu is displayed on the left-hand side of the display.
2. Select the *Settings* menu.
3. Select the *System* menu.
4. Select the *Control* menu.
5. For the option *TV-Out Mode* select the desired format PAL or NTSC.
6. Enable the *TV-Out* option by sliding the selector switch to the right.
  - ⇒ The *TV-Out* selector switch is highlighted in blue (OM).
  - ⇒ The TV output is activated.
7. Open the sealing cap at the AV output (3).
8. Connect the supplied or another suitable AV cable to the device and to the screen.

## Switching the device off

1. Press and hold the Power button (13) for approx. 3 s.
2. Confirm the prompt with *OK*.
  - ⇒ The message "power off" is displayed and the camera switches off after a few seconds.
3. Close the display (1).
4. Fix the protective cap to the IR lens (10).



## Software

You can either select the functions directly via the touch display, or using the arrow buttons and the OK button (16).



### Info

If the F button (21) is illuminated in blue, autofocus is activated. In this case, the functions cannot be selected using the arrow buttons.

### Main menu

- ✓ The start screen is displayed.



1. Press the C button (17) on the control panel or tap the Trotec logo on the display (1) to open the main menu.  
⇒ The main menu is displayed on the left-hand side of the display.

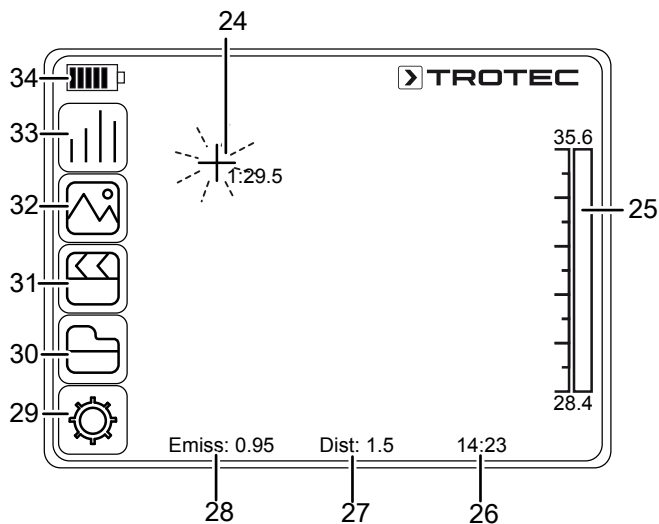

The main menu consists of the following menus:

Icon	Function
	Analysis menu (33)
	Image menu (32)
	Media menu (31)
	File menu (30)
	Settings menu (29)

### Analysis menu

The following settings can be made in this menu:

Icon	Setting	Function
	Spots	Use / edit measuring spot
	Area	Use / edit area
	Line	Use / edit line
	ISO	Make settings for isotherms

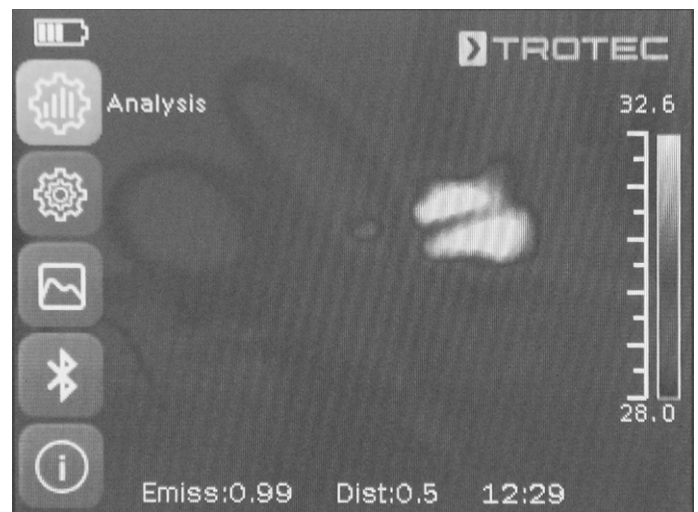

2. You can either select the submenus directly via the touch display, or using the arrow buttons and the OK button (16).

**Use / edit measuring spot submenu**

The following settings can be made in this submenu:

- Setting a measuring spot
- Deleting a measuring spot
- Making settings for a measuring spot

**Setting a measuring spot**

1. Press the *Spots* button.
  - ⇒ A measuring spot appears on the display.
  - ⇒ Next to the measuring spot, a number (e.g. 1) and the current temperature are displayed, provided that this was set in the general settings for this spot.
2. Tap the measuring spot and drag it to the desired position.
  - ⇒ The currently active measuring spot is highlighted in green.
3. You can add up to eight measuring spots if needed.

**Deleting a measuring spot**

1. Tap the measuring spot and drag it to the recycle bin appearing in the bottom right corner of the display.
  - ⇒ The measuring spot has been deleted.

**Making settings for a measuring spot**

1. When the measuring spot is active, press the OK button (16) or briefly tap the measuring spot twice.
  - ⇒ The settings for the measuring spot are displayed.



Setting		Function
Display	Hide	Hide measuring spot
	Show	Show measuring spot
Mode	Manual	The position of the measuring spot can be changed manually.
	Max	The measuring spot automatically switches to the position with the highest temperature.
	Min	The measuring spot automatically switches to the position with the lowest temperature.
Temp.	Off	Temperature for the measuring spot is not displayed.
	On	Current temperature for the measuring spot is displayed next to the measuring spot.
Background	Hide	Temperature and number of the measuring spot are displayed without a background.
	Show	Temperature and number of the measuring spot are framed by a background.
Alarm Mode	Off	Alarm function for the measuring spot is switched off.
	Above	Acoustic alarm sounds as soon as the temperature at the measuring spot is above the alarm temperature.
	Below	Acoustic alarm sounds as soon as the temperature at the measuring spot is below the alarm temperature.
	Equal	Acoustic alarm sounds as soon as the temperature at the measuring spot equals the alarm temperature.
Alarm Temp		Enter temperature for alarm mode

**Use / edit area submenu**

The following settings can be made in this submenu:

- Creating an area
- Deleting an area
- Making settings for an area

### Creating an area

1. Press the *Area* button.
  - ⇒ An area appears on the display.
  - ⇒ Inside the area a number (e.g. A1) is displayed.
  - ⇒ Next to the area, the temperature indications set are displayed.
2. Tap the middle of the area and drag it to the desired position.
3. Tap the corners of the area to increase or reduce the size of the area.
4. You can add up to two areas if needed.

### Deleting an area

1. Tap the area and drag it to the recycle bin appearing in the bottom right corner.
  - ⇒ The area has been deleted.

### Making settings for an area

1. When the area is active, press the OK button (16) or briefly tap the area twice.
  - ⇒ The settings for the area are displayed.

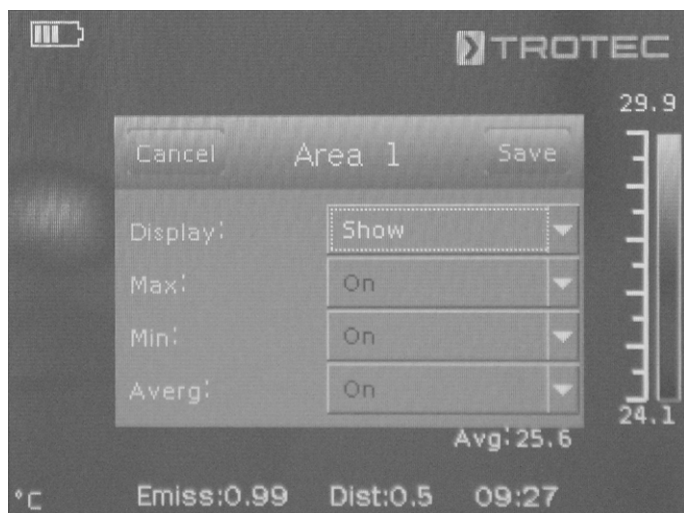

Setting		Function
Display	Hide	Hide area
	Show	Show area
Max	Off	Display deactivated
	On	A spot inside the area indicates the highest temperature. To the right of the area, the highest temperature inside the area is displayed as a number.
Min	Off	Display deactivated
	On	A spot inside the area indicates the lowest temperature. To the right of the area, the lowest temperature inside the area is displayed as a number.
Average	Off	Display deactivated
	On	To the right of the area, the average temperature inside the area is displayed as a number.

### Use / edit line submenu

The following settings can be made in this submenu:

- Activating a line
- Deleting a line

### Activating a line



#### Info

Deactivate the autofocus by pressing the F button (21) to prevent the focus function and the touch-based menu/feature control from influencing one another.

1. Press the *Line* button.
  - ⇒ A line and the temperature profile along this line are displayed.
  - ⇒ Above the line, a triangle pointing to a spot on the line appears. The temperature at this spot is displayed as a number.
2. When the line is activated, press the up / down arrow buttons (23 / 18) or tap the line and drag it up or down. The triangle marks the measuring spot on the line and can be shifted to the left or right.

### Deleting a line

1. Tap the line and drag it to the recycle bin appearing in the bottom right corner.

**Make settings for isotherms submenu**

Isotherms are colours of the same temperature. In this mode the thermal imaging camera highlights all areas within a certain previously specified temperature range (isotherm window) by means of a selected, particularly noticeable colour. This can e.g. be drops below dew point at building surfaces or thermally critical areas in control cabinets etc.

The following settings can be made in this submenu:

- Display
- Mode
- Colour
- Alarm



Setting		Function
Display	Hide	Hide isotherms
	Show	Show isotherms for the selected area
Mode	Under Below	Show isotherms below the lower limit
	Over Above	Show isotherms above the upper limit
	Interval	Show isotherms within the lower and upper limit (interval)
	Dual Below	Show isotherms within the lower and upper limit (interval) and below the lower limit
	Dual Above	Show isotherms within the lower and upper limit (interval) and above the upper limit

Setting		Function
Colour	Green	Colour isotherms green
	Black	Colour isotherms black
	White	Colour isotherms white
	Translucent	Show isotherms in a translucent manner
Fluorescent		Colour isotherms in fluorescent colours
Alarm	Off	Switch alarm off
	On	Switch alarm on
Alarm Value		Enter percentage value for the alarm; refers to the percentage of ISO colours in the image
Lower limit		Enter temperature for lower limit
Upper limit		Enter temperature for upper limit

**Image menu**

The following settings can be made in this menu:

Icon	Setting	Function
	Mode	Select camera mode Show / hide image bars / analysis tools
	Palette	Select colour palette
	Adjust	Set span and level

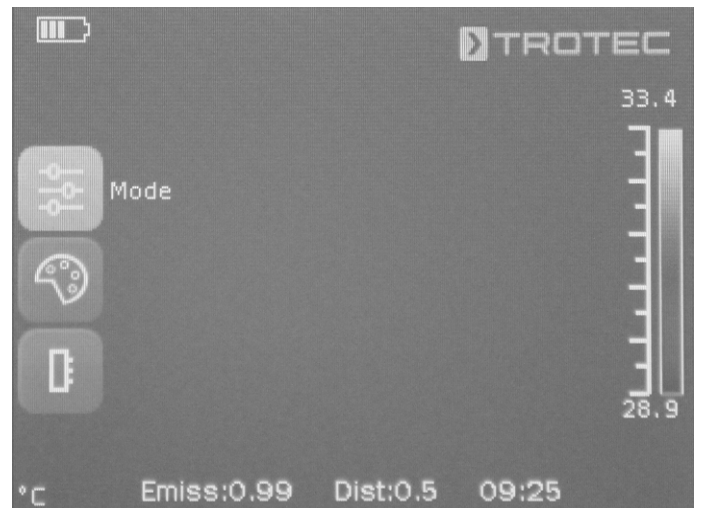





**Info**

Deactivate the autofocus by pressing the F button (21) to prevent the focus function and the touch-based menu/feature control from influencing one another.

Setting	Designation	Function		
Selecting the camera mode	IR	IR image is displayed		
	CCD	Camera image is displayed		
	Merg	The IR image and camera image are superimposed (DuoVision) The position and intensity of the overlay can be adjusted manually.	Pos	Position of the camera image can be shifted: <ul style="list-style-type: none"> <li>• Move the image with your finger until the contours match the IR image.</li> <li>• After having shifted the image as desired, return to the <i>Merge</i> menu, scroll down the list to select <i>Done</i>, and confirm and save the settings by pressing the <i>Apply</i> button.</li> </ul>
	Fusion- Plus	The IR image and contours from the camera image are superimposed (DuoVision Plus); the position of the overlay can be adjusted manually.	Pos	Position of the camera image can be shifted: <ul style="list-style-type: none"> <li>• Move the image with your finger until the contours match the IR image.</li> <li>• After having shifted the image as desired, return to the <i>Merge Plus</i> menu, scroll down the list to select <i>Done</i>, and confirm and save the settings by pressing the <i>Apply</i> button.</li> </ul>
	Image only	Display of the IR image without any additional information such as the temperature scale or global parameters		
Selecting the colour palette	Palette	Select the desired colour palette for the IR image		
Setting the span and level	M.L/S	Select the span and level manually		
	A.L/S	Span and level are constantly set automatically.		
	A.Level	Set span manually; level is constantly set automatically.		
	A.Span	Set level manually; span is constantly set automatically.		

**Media menu**

The following settings can be made in this menu:

Icon	Setting	Function
	Snapshot	For taking a photo
	Edit	Edit a photo
	Voice	Record a voice note
	Video	Record a video / Stop recording
	Replay	Play a video



**Take a photo submenu**

Please proceed as follows to take a photo:

1. Press the *Snapshot* button.
  - ⇒ The photo is taken and saved.
  - ⇒ The storage path is briefly shown on the display.
  - ⇒ The *Media* menu is displayed again after a few seconds.





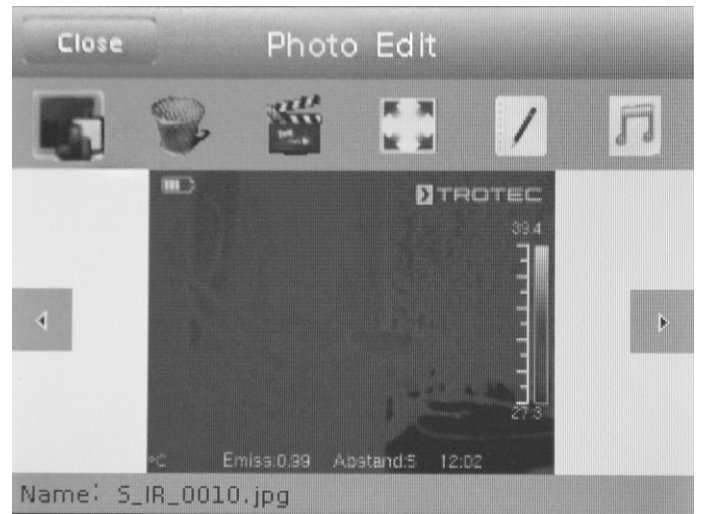

Taking a photo using the S button (14):

1. Press and hold the S button (14) for approx. 5 s.
  - ⇒ The photo is taken and saved.
  - ⇒ The storage path is briefly shown on the display.

**Edit a photo submenu**



You can access the following functions from this menu:

Icon	Function
	Display photo
	Delete photo
	Start slide show
	Display photo on full screen
	Add image description
	Add voice note

### Add a voice note submenu

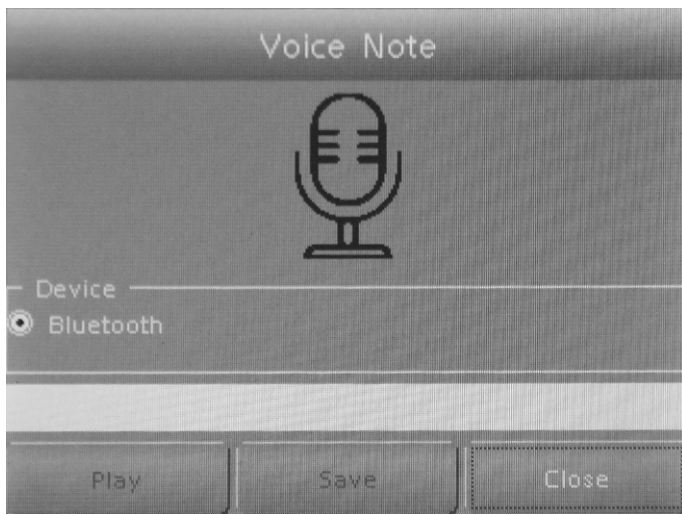

Please proceed as follows to record a voice note:

- ✓ The Bluetooth headset is switched on and connected to the camera via Bluetooth (see chapter Bluetooth submenu).
- 1. Press the microphone in the top middle of the display.
  - ⇒ The microphone on the display turns green.
  - ⇒ Recording of the voice note starts.
- 2. To stop recording, press the microphone on the display once again.
  - ⇒ The microphone on the display is no longer green.
  - ⇒ Recording of the voice note is completed.
- 3. To save the voice note, press the *Save* button.
  - ⇒ The voice note is stored on the device.

### Recording a video / Stopping recording submenu



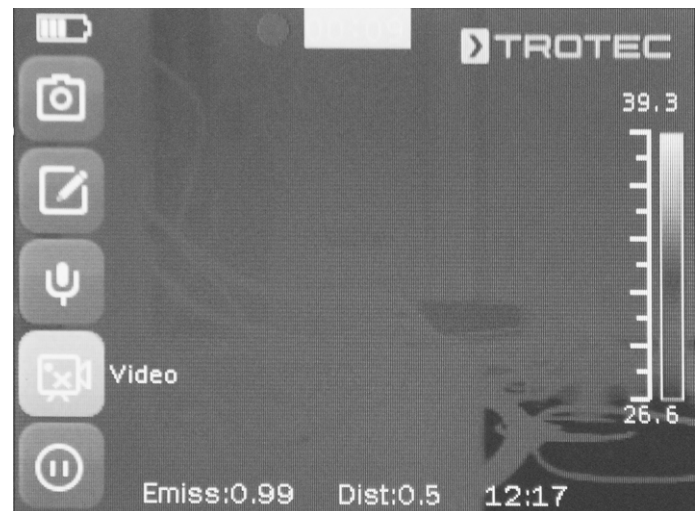

Please proceed as follows to record a video:

1. Press the *Video* button.
  - ⇒ The duration of the recording is displayed in the top middle.
  - ⇒ Recording of the video starts.
2. Press the *Video* button again to stop recording.
  - ⇒ The duration of the recording is no longer displayed in the top middle.
  - ⇒ Recording is stopped.



**Replay video submenu**

You can access the following functions from this menu:

Icon	Function
	Play video
	Stop video
	Select previous video
	Select next video
	Play video on full screen
	Show videos
	Return to <i>Media</i> menu

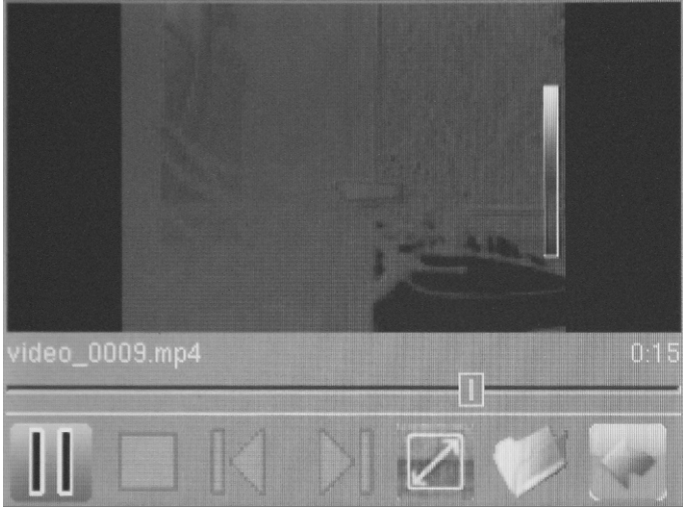





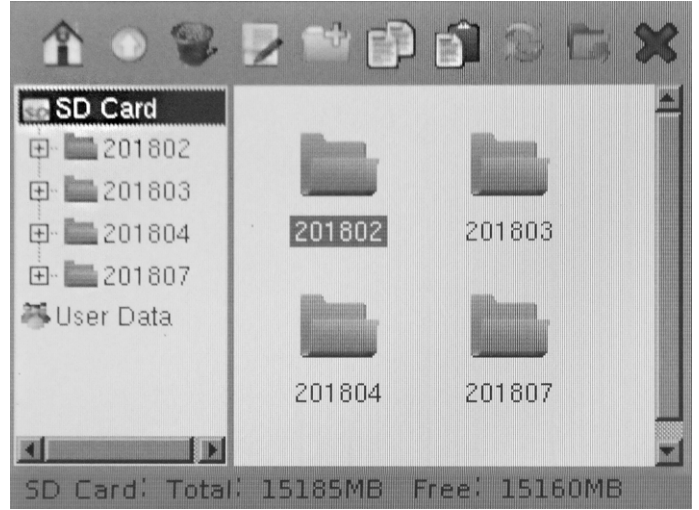





**File menu**

The *File* menu allows you to access the internal system file manager.



The file manager provides the following functions:

Icon	Function
	Show file manager homepage
	Select parent folder
	Delete selected file / folder
	Change file name
	Create new folder
	Copy selected file
	Paste copied file
	Refresh display
	Use selected folder as storage location for videos and photos
	Return to <i>Media</i> menu



### Settings menu

The following submenus can be selected in this menu:

- Analysis
- System
- Image
- Bluetooth (optional)
- System info

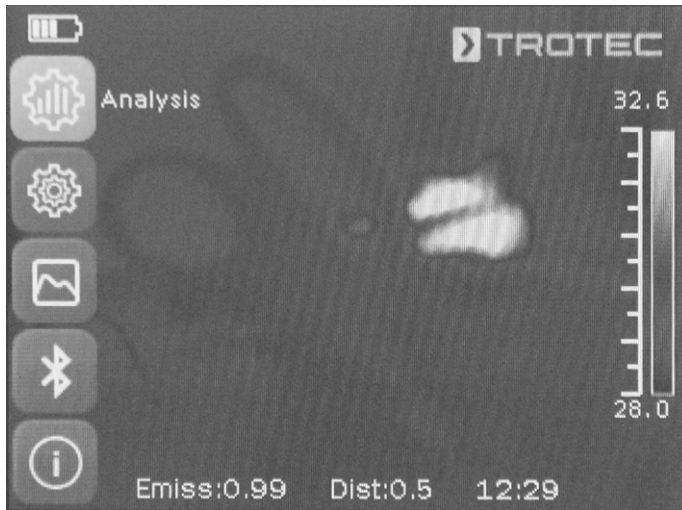

### Analysis submenu

The following settings can be made in this menu:

Designation	Function	
<i>Global Param.</i>	<i>Emissivity</i>	Set emissivity, value range 0.00 to 1.00
	<i>Distance</i>	Set distance to object
	<i>Ambi. Temp</i>	Set ambient temperature
	<i>Refl. Temp</i>	Set reflected temperature of the environment
	<i>Humidity</i>	Set relative humidity of the environment
	<i>Offset</i>	Set temperature offset (shift of the camera's internal calibration curve around zero)
<i>Background</i>	Hide	
	Show	
<i>Reset</i>	Reset factory settings	
<i>Temp. Range</i>	Select temperature range: -20 °C to +150 °C or 140 °C to 600 °C	
<i>Emiss Table</i>	List of different emissivities	
<i>Comp. Temp.</i>	Comparison of a selected measuring spot with a set reference temperature	
<i>Lens</i>	When using an optional interchangeable lens, enter the aperture angle of the lens used (and specified in the menu)	

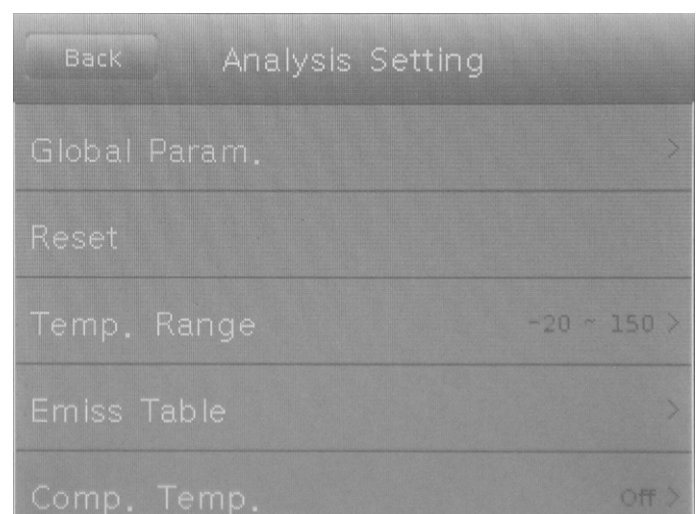

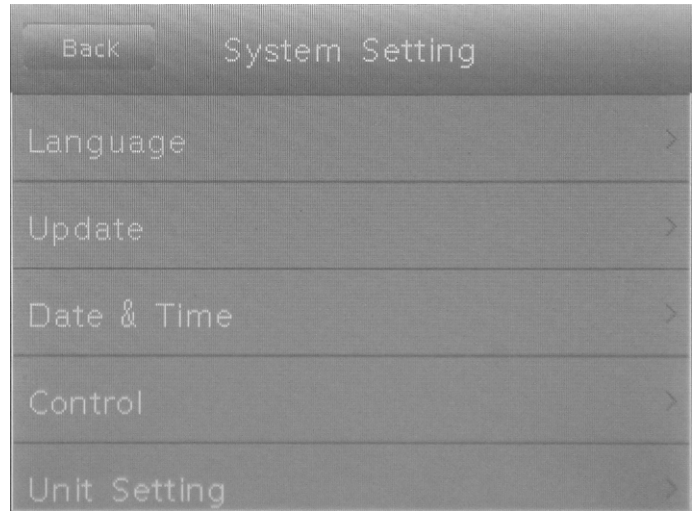
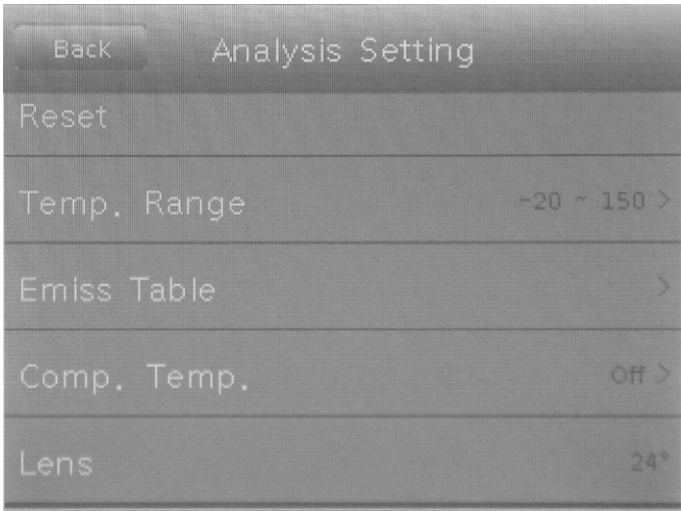

**System submenu**

The following submenus can be selected in this menu:

Submenu	Settings
Language	Select language for menu texts
Update	Start software update / Perform backup
Date & Time	Set date and time
Control	Make settings regarding laser, TV output, LED and USB; configure multifunction button
Unit Setting	Set units for length (metres or feet) and temperature (Celsius or Fahrenheit)
Power Manager	Activate / Deactivate screen saver and automatic switch-off

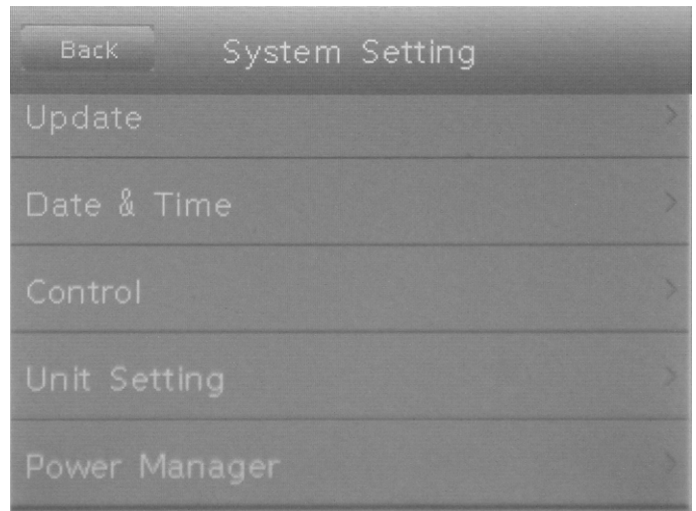

**Connecting an external monitor**

You can connect an external monitor to the AV output (3). In the *Control* submenu, you can adapt the output format to the video format of the monitor (TV-Out mode) as well as activate and deactivate the output to the external monitor by simultaneously pressing the down arrow button (18) and the up arrow button (23).

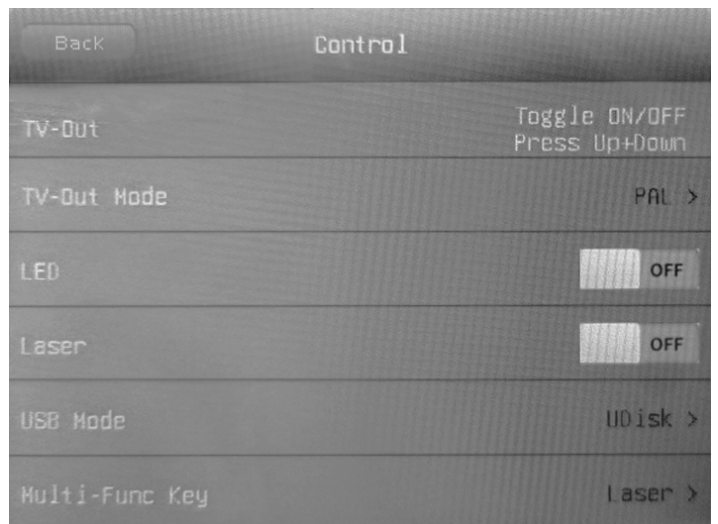



**Info**

Observe that with the XC600 model the display does not automatically change to the internal display if the cable of the external monitor is removed from the AV output. Therefore, deactivate the TV output before disconnecting the external monitor from the device. If the TV output is not deactivated, the display of the device will remain black after the external monitor has been disconnected from the AV output (3).

**Image submenu**



Submenu	Settings
Shutter Interval	Set shutter interval for IR lens
Quick Launcher	Activate or deactivate quick launch button
Save image only	Activate or deactivate Save image only
Save at regular intervals	Activate the automatic saving function and select intervals for automatic image storage

**Bluetooth submenu**

In this submenu you can connect the device to the Bluetooth headset. To do so, please proceed as follows:

1. In the Settings tab, press the arrow button down (18).  
⇒ The Start Bluetooth menu item is selected.
2. Enter the device name.
3. Use the arrow buttons right (15) or left (20) to navigate to the Search tab.
4. Press the *Search* button.  
⇒ After a few seconds, the Bluetooth headset located within reach is displayed.
5. Press the *Connect* button to connect the device to the Bluetooth headset.  
⇒ You can now use the connected Bluetooth headset.

**System info submenu**

Submenu	Settings
System information	Displays the system information including the serial number and firmware version. The device can be reset to factory settings by pressing the red button.

**Emissivity**

The emissivity is used to describe the energy radiation characteristic of a material (see also chapter Thermography terms).

A material's emissivity depends on various factors:

- composition,
- surface condition,
- temperature.

The emissivity can range between 0.01 and 1 (in theory). The following rule of thumb can be assumed:

- When a material is rather dark and its surface texture matt, it probably has a high emissivity.
- The brighter and smoother the surface of a material, the lower will be its emissivity, presumably.
- The higher the emissivity of the surface to be measured, the better it is suited for non-contact temperature measurement by use of a pyrometer or thermal imaging camera, since falsifying temperature reflections can be neglected.

Entering an emissivity as accurate as possible is indispensable for a precise measurement.

Most organic materials have an emissivity of 0.95. Metals or shiny materials come with a much lower value.

Material	Temperature (°C)	Emissivity (approximate)
<b>Aluminium</b>		
Polished aluminium	100	0.09
Customary aluminium foil	100	0.09
Electrolytically chromium-plated aluminium oxide	25 – 600	0.55
Mild aluminium oxide	25 – 600	0.10 – 0.20
Strong aluminium oxide	25 – 600	0.30 – 0.40
<b>Iron</b>		
Polished cast iron	200	0.21
Processed cast iron	20	0.44
Polished tempered iron	40 – 250	0.28
Polished steel ingot	770 – 1040	0.52 – 0.56
Raw, welded steel	945 – 1100	0.52 – 0.61
Surface iron oxide	20	0.69
Fully rusted surface	22	0.66
Rolled iron plate	100	0.74
Oxidized steel	198 – 600	0.64 – 0.78
Cast iron (oxidizing at 600 °C)	198 – 600	0.79
Steel (oxidizing at 600 °C)	125 – 520	0.78 – 0.82
Electrolytic iron oxide	500 – 1200	0.85 – 0.95
Iron plate	925 – 1120	0.87 – 0.95
Cast iron, heavy iron oxide	25	0.80
Tempered iron, iron oxide	40 – 250	0.95

Material	Temperature (°C)	Emissivity (approximate)
Melting surface	22	0.94
Molten cast iron	1300 – 1400	0.29
Molten structural steel	1600 – 1800	0.28
Liquid steel	1500 – 1650	0.28
Pure iron ore	1515 – 1680	0.42 – 0.45
Galvanized, shiny iron plate	28	0.23
<b>Copper</b>		
Copper oxide	800 – 1100	0.13 – 0.16
Copper mirror	100	0.05
Strong copper oxide	25	0.078
Liquid copper	1080 – 1280	0.13 – 0.16
<b>Brass</b>		
Brass mirror	28	0.03
Brass oxide	200 – 600	0.59 – 0.61
<b>Chromium</b>		
Polished chrome	40 – 1090	0.08 – 0.36
<b>Gold</b>		
Gold mirror	230 – 630	0.02
<b>Silver</b>		
Polished silver	100	0.05
<b>Nickel</b>		
Nickel chromium (heat-resistant)	50 – 1000	0.65 – 0.79
Nickel chromium alloy	50 – 1040	0.64 – 0.76
Nickel chromium alloyed (heat-resistant)	50 – 500	0.95 – 0.98
Nickel silver alloy	100	0.14
Polished, galvanized	25	0.05
Galvanized	20	0.01
Nickel wire	185 – 1010	0.09 – 0.19
<b>Lead</b>		
Pure lead (not oxidized)	125 – 225	0.06 – 0.08

Material	Temperature (°C)	Emissivity (approximate)
<b>Stainless steel</b>		
18 -8	25	0.16
304 (8Cr, 18Ni)	215 – 490	0.44 – 0.36
310 (25Cr, 208Ni)	215 – 520	0.90 – 0.97
<b>Tin</b>		
Finished tin plate	100	0.07
Heavily oxidized	0 – 200	0.60
<b>Zinc</b>		
Oxidizing at 400 °C	400	0.01
Zinc oxide ash	25	0.28
<b>Magnesium</b>		
Magnesia	275 – 825	0.20 – 0.55
<b>Metallic materials</b>		
Hg	0 – 100	0.09 – 0.12
Sheet metal		0.88 – 0.90
<b>Non-metallic materials</b>		
Brick	1100	0.75
Fire brick	1100	0.75
Graphite (lamp black)	96 – 225	0.95
Porcelain enamel (white)	18	0.90
Asphaltum	0 – 200	0.85
Glass (surface)	23	0.94
Lime paint	20	0.90
Oak	20	0.90
Piece of coal		0.85
Isolation piece		0.91 – 0.94
Glass tube		0.90
Porcelain enamel products		0.90
Porcelain enamel designs		0.83 – 0.93
Solid materials		0.80 – 0.93
Ceramic (vase)		0.90
Film		0.90 – 0.93
Heat-resistant glass	200 – 540	0.85 – 0.95

Material	Temperature (°C)	Emissivity (approximate)
Mica		0.94 – 0.95
Glass		0.91 – 0.92
Level chalk layer		0.88 – 0.93
Epoxy glass plate		0.86
Epoxy hydroxybenzene plate		0.80
<b>Electric materials</b>		
Semiconductor		0.80 – 0.90
Transistor (plastic sealed)		0.30 – 0.40
Transistor (metal diode)		0.89 – 0.90
Gold-plated copper sheet		0.30
Soldered plated copper		0.35
Zinc-plated lead wire		0.28
Brass wire		0.87 – 0.88

## Thermography terms

### Span (contrast)

If the temperatures in the image are homogeneously distributed and close together, the image might not be very colourful / contrasty, and the contours might not be easily visible. To increase the image's contrast, press the up or down button of the central menu keyboard. This increases or reduces the temperature range set. The representation of individual thermal areas in the image changes and becomes more contrasty.

### Level (average temperature / temperature level / brightness)

When changing the span (see Span), it often makes sense to also adjust or shift the average temperature (Level). If, for instance, the span is reduced to a minimum first and then the level of this extremely narrowed temperature range is shifted up/down (by pressing the right/left arrow button), the image will become useless even in parts as it will either have a totally excessive or insufficient contrast. However, this allows you to visualize even the smallest temperature differences in the object when traversing the individual temperature sections.

## Emission

Any object whose temperature lies above absolute zero (-273.15 °C) emits heat radiation. Its surface condition (e.g. colour, structure, material composition etc.) and temperature, among other things, determine how well the heat is emitted. The emissivity of an object indicates how much heat it radiates compared to an ideal black body. An ideal black body has a theoretical emissivity of 1. Other factors such as transmission and reflection can be neglected in this ideal case. In practice, however, this is not possible. Surfaces that strongly reflect in the visible light spectrum are often also highly reflective in the infrared spectral range, as is the case with polished aluminium for instance.

The formula is: **transmission + reflection + emission = 1**

In most cases, the transmission factor can be neglected. If the surface to be thermographed is highly reflective, the share of reflection increases correspondingly and the share of emission decreases.

Example:

- transmission = 0
- reflection = 0,8
- emission = 0.2

Highly reflective surfaces reflect all temperatures whatsoever from surrounding heat sources, which are thus indirectly captured and measured by the thermal imaging camera, while the surface temperature of the actual measuring object is not being measured. To overcome this problem, special labels or sprays with a high defined emissivity are often applied on the surface to be measured.

The general rule is: The higher the emissivity, the lower the reflectance, the easier the thermography.

## Reflected temperature

The location of heat sources in the surroundings influencing the measurement and the determination of the average temperature which is emitted by them and can be reflected by the object to be thermographed.

## Errors and faults

The device has been checked for proper functioning several times during production. If malfunctions occur nonetheless, check the device according to the following list.

Fault	Cause	Remedy
Camera does not take/record pictures/videos	Internal memory full.	Delete files no longer needed to free up storage space.
Battery quickly discharged	Battery too old or damaged.	Please contact the Trotec customer service.
Battery not charging	Charging cable not inserted correctly.	Check the connection for proper fit.
	Battery too old or damaged.	Please contact the Trotec customer service.
	Contacts of the USB type C charging socket at the device or contacts of the USB type C cable dirty.	Check the contacts for dirt. If necessary, carefully remove any dirt from inside the socket with a suitable object without damaging the contacts. Otherwise, use a dry, clean cloth to clean the contacts.
	Contacts of the USB type C charging socket at the device or contacts of the USB type C cable damaged.	Check the contacts for visible damage. If the USB type C cable is damaged, please replace it with an undamaged one. If the USB type C socket at the device is damaged, please contact the Trotec customer service.

## Maintenance and repair

### Charging the battery



#### Warning of electrical voltage

Before each use of the charger or power cable, check for damages. If you notice damages, stop using the charger or power cable!

The battery should be charged prior to initial start-up and when the battery is low. The current battery status can be checked via the battery status indicator (34).

Always use the power adapter included in the scope of delivery to charge the battery. To do so, please proceed as follows:

1. Plug the charger into a sufficiently fused power socket.  
Only use the original charger or one with identical specifications, for otherwise both battery and camera could be damaged!
2. Plug the USB type C plug of the power adapter into the USB type C port (4) of the camera.
  - ⇒ The battery LED (22) of the camera is illuminated in red.
  - ⇒ The battery is fully charged when the battery LED (22) of the camera is illuminated in green.
  - ⇒ Remove the power adapter from the mains socket and from the camera.

### Cleaning

Clean the device with a soft, damp and lint-free cloth. Make sure that no moisture enters the housing. Do not use any sprays, solvents, alcohol-based cleaning agents or abrasive cleaners, but only clean water to moisten the cloth.

### Repair

Do not modify the device or install any spare parts. For repairs or device testing, contact the manufacturer.

## Disposal



The icon with the crossed-out waste bin on waste electrical or electronic equipment stipulates that this equipment must not be disposed of with the household waste at the end of its life. You will find collection points for free return of waste electrical and electronic equipment in your vicinity. The addresses can be obtained from your municipality or local administration. For further return options provided by us please refer to our website [www.trotec24.com](http://www.trotec24.com).

The separate collection of waste electrical and electronic equipment aims to enable the re-use, recycling and other forms of recovery of waste equipment as well as to prevent negative effects for the environment and human health caused by the disposal of hazardous substances potentially contained in the equipment.



In the European Union, batteries and accumulators must not be treated as domestic waste, but must be disposed of professionally in accordance with Directive 2006/66/EC of the European Parliament and of the Council of 6 September 2006 on batteries and accumulators. Please dispose of batteries and accumulators according to the relevant legal requirements.



Trotec GmbH

Grebbener Str. 7  
D-52525 Heinsberg

☎ +49 2452 962-400

☎ +49 2452 962-200

✉ [info@trotec.com](mailto:info@trotec.com)

[www.trotec.com](http://www.trotec.com)